

Code: HG-140-150W

SEMICONDUCTOR HEATER **HG-140-150W**

Net: **32.60 EUR** Gross: **32.60 EUR**



The HG-140-150W semiconductor heater operates based on a PTC thermistor.

Heaters and fan heaters prevent condensation of water vapor and maintain the proper operating temperature of the devices. For optimum circulation of air it is advisable to install the convection heaters in the bottom part of the cabinet in a vertical position.

Attention! The device is designed for use only in closed cabinets. For safety reasons, you should keep a minimum distance of 50mm from the cables and other equipment. The PTC thermistors are not suitable for series connection.

To maintain the constant temperature level in a cabinet, you should connect in series a suitable thermostat to the heater.

SPECIFICATION

Heating element:	PTC thermistor - semiconductor, self regulating
Radiator:	Aluminum - Extruded profiles, Anodized surface
Connectors:	Cable terminals - 3 pcs
Power supply:	110 V ... 250 V AC/DC
Current consumption:	max. 9.0 A - at the time of switching
Power:	150 W
Assembly:	DIN TS-35 rail, vertical
Enabled heater temp:	120 °C ... 140 °C
Operation temp:	-45 °C ... 70 °C
Weight:	0.47 kg
Dimensions:	258 x 70 x 58 mm
Guarantee:	2 years

PRESENTATION

Front view:



DELTA-OPTI Monika Matysiak; <https://www.delta.poznan.pl>
POL; 60-713 Poznań; Graniczna 10
e-mail: delta-opti@delta.poznan.pl; tel: +(48) 61 864 69 60



Connectors view:

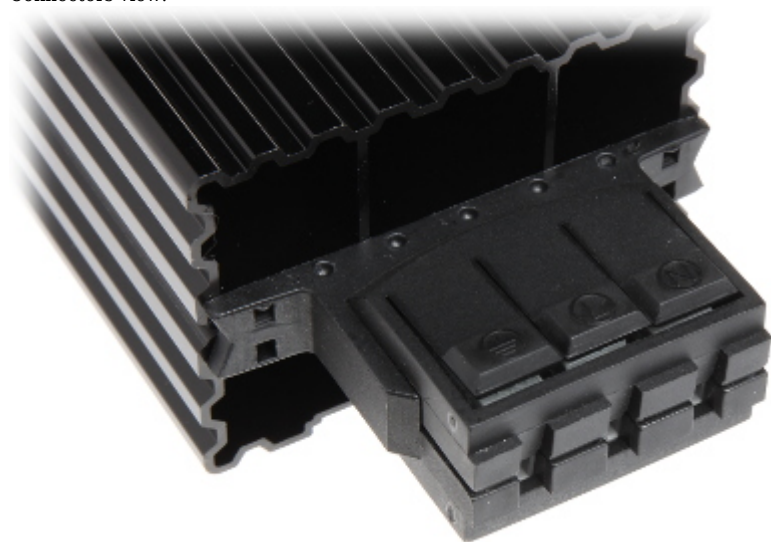

Mounting side view:





Side view:



Top view:



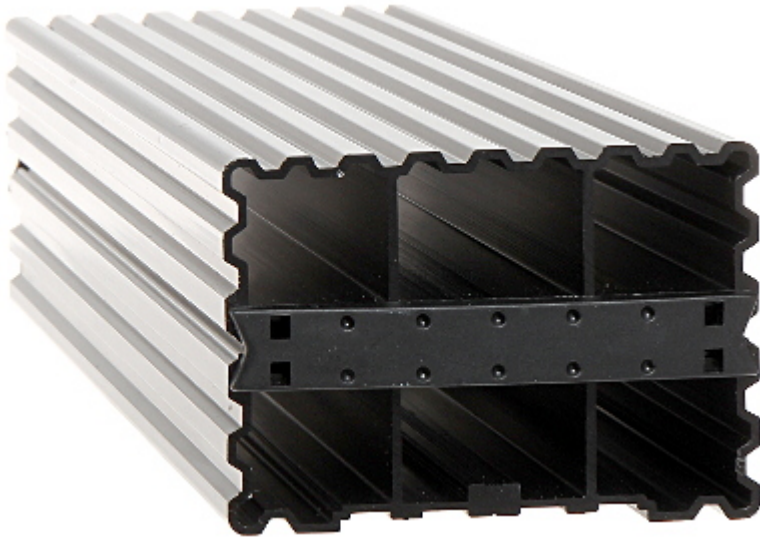

Dimensions:

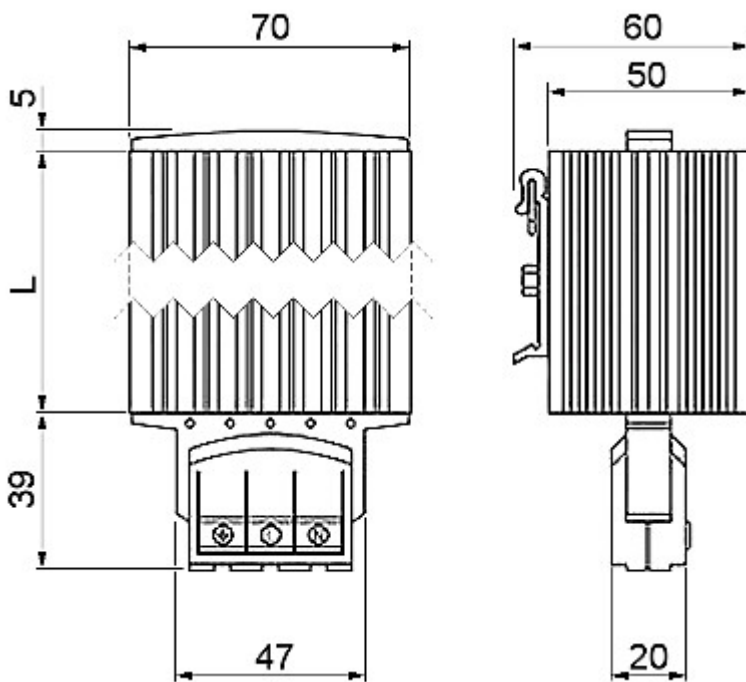

L = 220mm

OUR OPINIONS



- Small dimensions of the device.

PACKAGE

Dimensions (L x W x H): 0x0x0 mm	Gross Weight: 0 kg
----------------------------------	--------------------



DELTA-OPTI Monika Matysiak; <https://www.delta.poznan.pl>
POL; 60-713 Poznań; Graniczna 10
e-mail: delta-opti@delta.poznan.pl; tel: +(48) 61 864 69 60