

Code: R5-24.13

ELECTRIC STRIKE **R5-24.13** REVERSIBLE

Net: **24.05 EUR** Gross: **24.05 EUR**



The electric strike of R5-24.13 type is designed for door and gates made from metal profiles, to work together with ratchet-latch or ratchet type door lock. It operates reversibly - it is open when power is off.

SPECIFICATION

Rated voltage:	24 V ± 2 V DC
Current consumption:	150 ... 175 mA DC
Application:	right-side door / left-side door
Ratched lock:	—
Memory function:	—
Reverse action:	✓
Clearance adjustment:	✓
Allowable thrust on the door at ratchet release:	30 N
Allowable load of the door impacting the lock:	3000 N
Allowable uninterrupted operation time:	unlimited
Weight:	0.128 kg
Dimensions:	16.5 x 29 x 68 mm
Guarantee:	2 years

PRESENTATION

DELTA-OPTI Monika Matysiak; <https://www.delta.poznan.pl>
POL; 60-713 Poznań; Graniczna 10
e-mail: delta-opti@delta.poznan.pl; tel: +(48) 61 864 69 60



Schematic diagram (principle of operation):

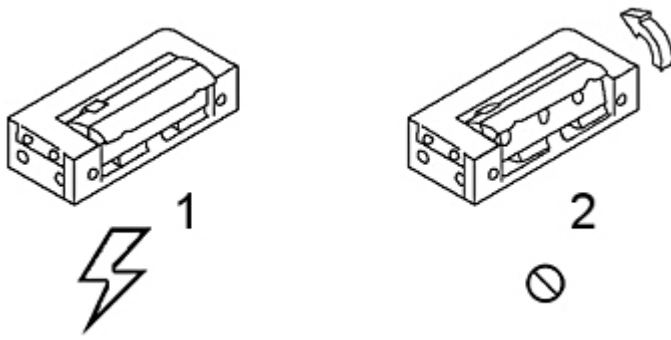

- 1. 24V
bolt locked
 - 2. no voltage
bolt unlocked
- Dimensions:

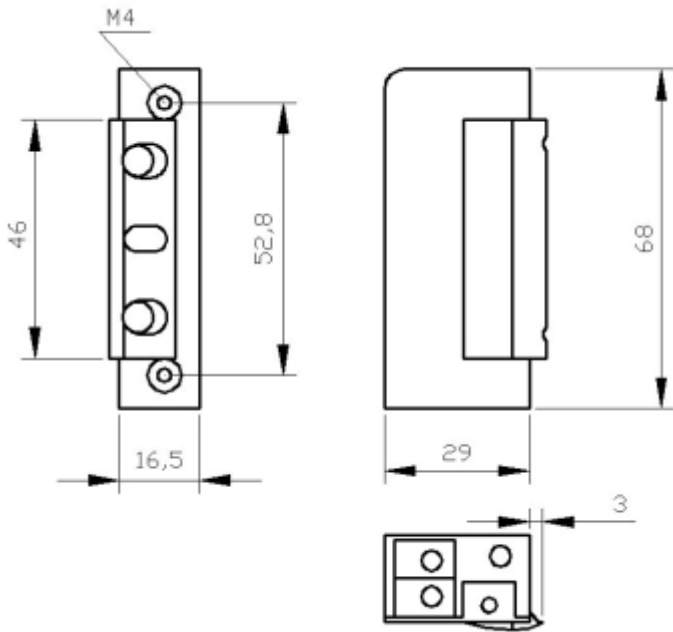

Determination of the left- and right side doors:

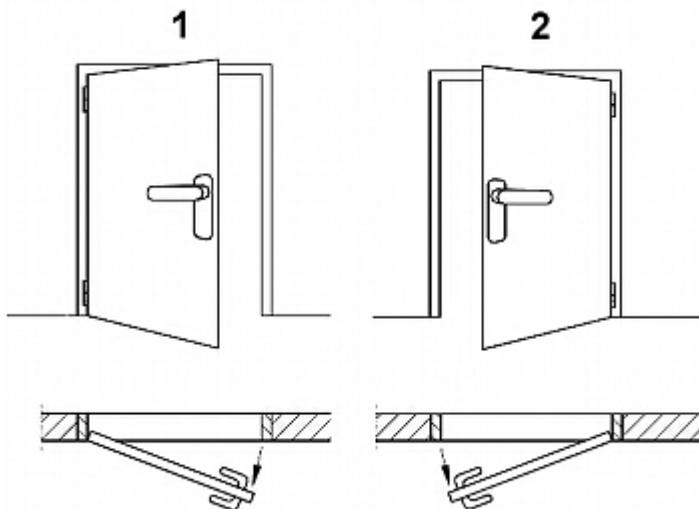

- 1. left-side door
- 2. right-side door



PACKAGE

Dimensions (L x W x H): 0x0x0 mm	Gross Weight: 0 kg
----------------------------------	--------------------

