

Code: HVL-031-150W

FAN HEATER HVL-031-150W

Net: 59.40 EUR Gross: 59.40 EUR

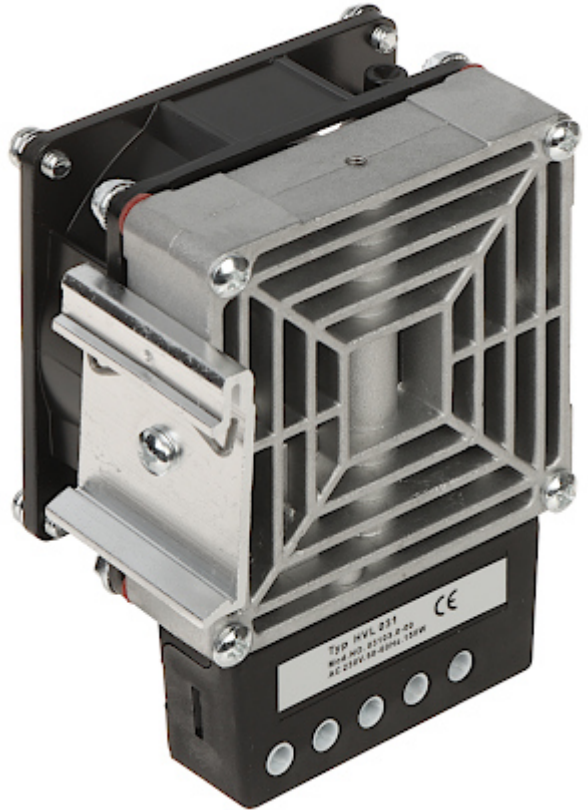

The HVL-031-150W fan heater is designed for installation in closed cabinets. Heaters and fan heaters prevent condensation of water vapor and maintain the proper operating temperature of the devices.

Attention! For safety reasons, you should keep a minimum distance of 150mm from the cables and other equipment.

To maintain the constant temperature level in a cabinet, you should connect in series a suitable thermostat to the fan heater.

SPECIFICATION

Heating element:	High power resistor
Radiator:	Aluminum - Die-cast housing, Glass bead blasted surface
Heating capacity:	150 W
Number of fan coolers:	1 pcs
Minimal airflow:	35 m ³ /h
Connectors:	Cable terminals - 3 pcs
Power supply:	110 V ... 265 V AC/DC
Power:	160 W
Assembly:	DIN TS-35 rail
Operation temp:	-45 °C ... 70 °C
Weight:	0.48 kg
Dimensions:	112 x 80 x 52 mm
Guarantee:	2 years

PRESENTATION

Front view:

DELTA-OPTI Monika Matysiak; <https://www.delta.poznan.pl>
POL; 60-713 Poznań; Graniczna 10
e-mail: delta-opti@delta.poznan.pl; tel: +(48) 61 864 69 60



Connectors view:



Rear view:



Mounting view:



Top view:

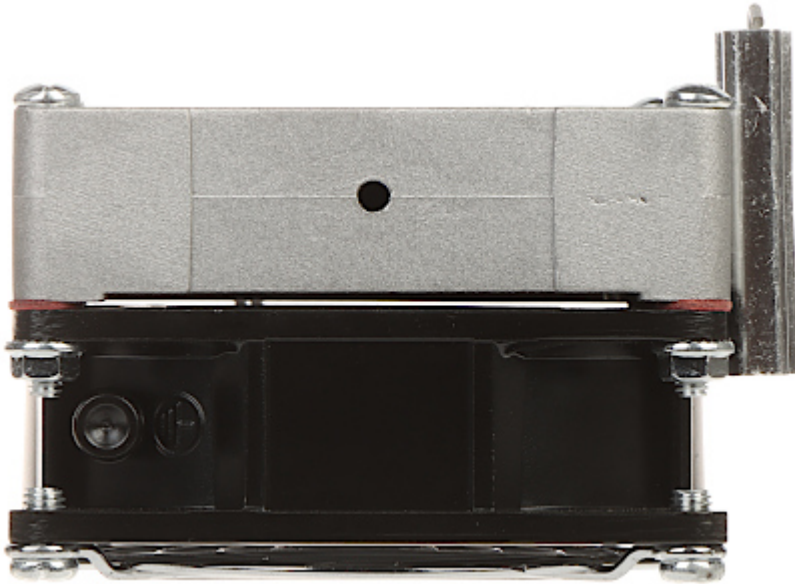

Dimensions:

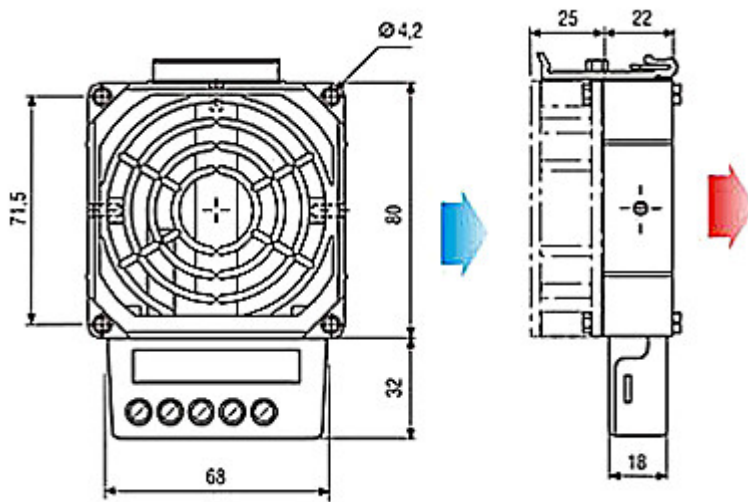

In the kit:



OUR OPINIONS

DELTA-OPTI Monika Matysiak; <https://www.delta.poznan.pl>
POL; 60-713 Poznań; Graniczna 10
e-mail: delta-opti@delta.poznan.pl; tel: +(48) 61 864 69 60



- Small dimensions of the device.

PACKAGE

Dimensions (L x W x H): 0x0x0 mm	Gross Weight: 0 kg
----------------------------------	--------------------

