

Code: APTI-H50V3-2812

AHD, HD-CVI, HD-TVI, PAL VANDALPROOF CAMERA **APTI-H50V3-2812**

2Mpx / 5Mpx 2.8 ... 12 mm

Net: **42.39 EUR** Gross: **52.14 EUR**

Megapixel camera with 1/2.7" CMOS sensor and AHD / HD-CVI / HD-TVI / CVBS.

The AHD / HD-CVI / HD-TVI interface allows to transmission of analog video signal via coaxial cable in max. 8 Mpx (4K UHD) resolution. During transmission there are no delays and is maintained the original, high quality image.

In the case of video transmission using a twisted pair cable and matching transformers (balun), be aware of the possibility of signal reflections and interfering signals.

Setting the camera in PAL mode allows to obtain an image in 960H resolution. The appropriate signal format selection is done by tilting and holding the joystick for 5 s without entering to the OSD menu. Changing the signal to the NTSC in the camera causes loss of image in connected AHD/HD-CVI/HD-TVI recorder.

The range of IR illumination according to the manufacturer data, depends on outer conditions (visibility - air transparency, environment, wall colors ie. scene reflectance). Camera is according to IP66 Index of Protection norm.

Attention! The camera is factory set to the resolution 2 Mpx (1080p).



SPECIFICATION

Standard:	AHD, HD-CVI, HD-TVI, CVBS
Sensor:	1/2.7 " CMOS
Matrix size:	5 Mpx
Resolution:	2592 x 1944 - 5 Mpx @ AHD / HD-TVI @ 20 fps, 12.5 fps , 2560 x 1440 - 4 Mpx @ AHD / HD-CVI / HD-TVI @ 25 fps, 30 fps , 1920 x 1080 - 1080p @ AHD / HD-CVI / HD-TVI , 960 x 576 - 960H @ PAL
Range of IR illumination:	30 m
IR illuminator power adjustment:	Automatic
Lens:	2.8 ... 12 mm
View angle:	• 88 ° ... 31 ° (manufacturer data) • 93 ° ... 35 ° (our tests result)
Video output:	1 Vpp 75 Ω, AHD / HD-CVI / HD-TVI / CVBS - Via OSD, selectable by switch
Main features:	• D-WDR - Wide Dynamic Range • DNR - Digital Noise Reduction • ICR - Movable InfraRed filter • AGC - Automatic Gain Control • Auto White Balance • Day/Night mode - configurable • Sharpness - sharper image outlines
OSD menu:	✓
Vandal-proof:	✓
"Index of Protection":	IP66

DELTA-OPTI Monika Matysiak; <https://www.delta.poznan.pl>
POL; 60-713 Poznań; Graniczna 10
e-mail: delta-opti@delta.poznan.pl; tel: +(48) 61 864 69 60

Power supply:	12 V DC / 400 mA
Power consumption:	≤ 4.8 W
Housing:	Dome - Metal
Color:	Graphite
Operation temp:	-20 °C ... 60 °C
Weight:	0.55 kg
Dimensions:	Ø 120 x 100 mm
Supported languages:	English
Manufacturer / Brand:	APTI
Guarantee:	2 years

PRESENTATION

Camera is out from clamping ring (the OSD menu controller visible):



Mounting side view:

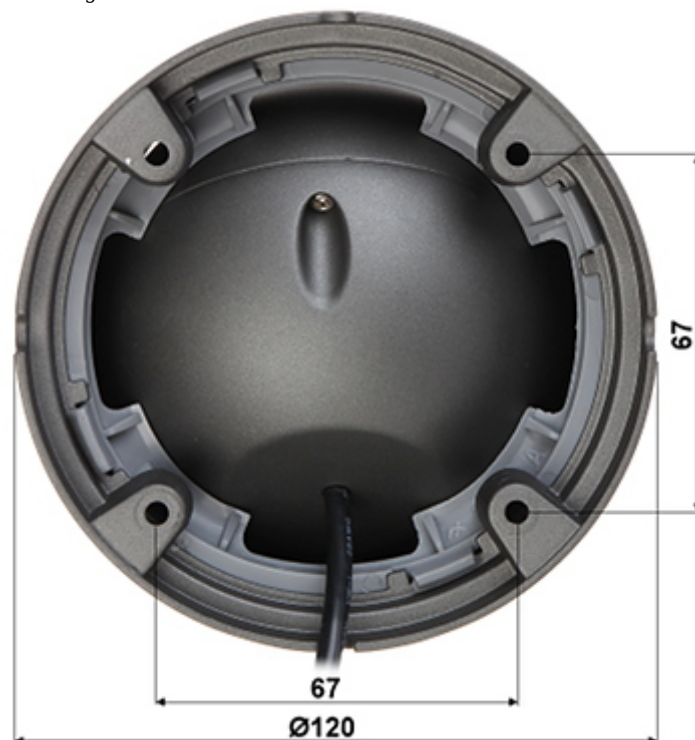

The appropriate signal format selection is done by tilting and holding the joystick for 5 s without entering to the OSD menu.
Changing the signal to the NTSC in the camera causes loss of image in connected AHD/HD-CVI/HD-TVI recorder:

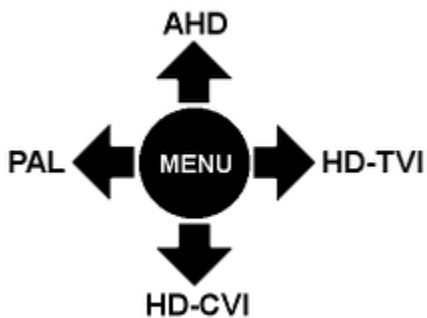

Configuration
1) Move the joystick in the correct direction
2) Turn on the power

In the kit:



OUR TESTS

AHD:

Camera image at artificial illumination (about 30Lux):

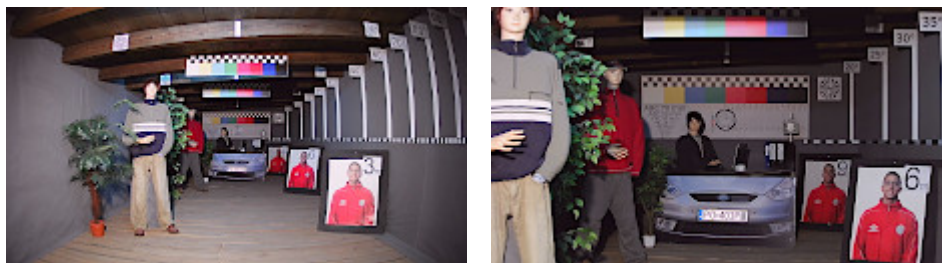

Camera image at night conditions with internal built-in IR illuminator on:



DELTA-OPTI Monika Matysiak; <https://www.delta.poznan.pl>
POL; 60-713 Poznań; Graniczna 10
e-mail: delta-opti@delta.poznan.pl; tel: +(48) 61 864 69 60



Camera image at direct strong light opposite to camera:



HD-CVI:

Camera image at artificial illumination (about 30Lux):

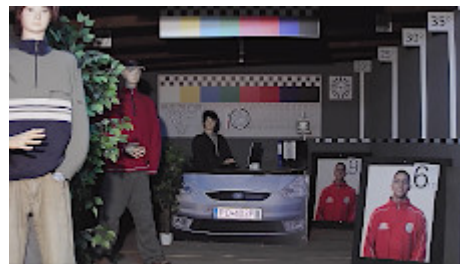

Camera image at night conditions with internal built-in IR illuminator on:



Camera image at direct strong light opposite to camera:

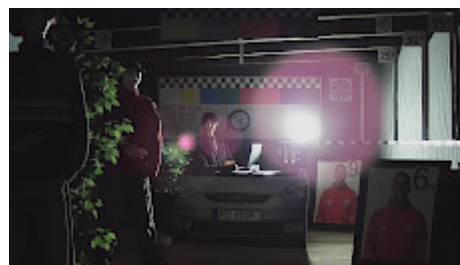

HD-TVI:

Camera image at artificial illumination (about 30Lux):

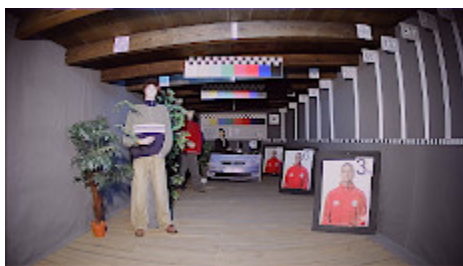

Camera image at night conditions with internal built-in IR illuminator on:



Camera image at direct strong light opposite to camera:

