

Code: DS-2CE56D8T-ITME(2.8mm)

HD-TVI CAMERA **DS-2CE56D8T-ITME(2.8mm)** - 1080p Hikvision

Net: **76.37 EUR** Gross: **93.94 EUR**

Megapixel camera with Progressive Scan CMOS sensor and HD-TVI (High Definition Transport Video Interface).

The HD-TVI interface allows to transmission of analog video signal via coaxial cable at resolutions up to 1080p. It enables the transmission of HD resolution images for even 500 m distance with keeping the low costs of the installation. During transmission there are no delays and is maintained the original, high quality image.

Housing construction allows to mount the camera to the ceiling and the wall (image is right oriented in both cases).



SPECIFICATION

Standard:	HD-TVI
Sensor:	Progressive Scan CMOS
Matrix size:	2.1 Mpx
Resolution:	1920 x 1080 - 1080p
Range of IR illumination:	20 m
IR illuminator power adjustment:	Automatic
Lens:	2.8 mm / F1.4
View angle:	<ul style="list-style-type: none">• 104 ° (manufacturer data)• 102 ° (our tests result)
Video output:	1 Vpp / 75 Ω - HD-TVI, BNC socket
Main features:	<ul style="list-style-type: none">• WDR - 120 dB - Wide Dynamic Range• 3D-DNR - Digital Noise Reduction• Sense-UP - (Slow Shutter) - Increase the sensor sensitivity• ICR - Movable InfraRed filter• AGC - Automatic Gain Control• Privacy zones - max. 4• Motion Detection - max. 4 zones• IR illuminator optimization• Mirror - Mirror image• BLC - Back Light Compensation• Auto White Balance• Sharpness - sharper image outlines
OSD menu:	OSD menu available via Hikvision HD-TVI recorder
Power supply:	<ul style="list-style-type: none">• PoC.af,• 12 V DC / 290 mA
Power consumption:	≤ 3.5 W

DELTA-OPTI Monika Matysiak; <https://www.delta.poznan.pl>
POL; 60-713 Poznań; Graniczna 10
e-mail: delta-opti@delta.poznan.pl; tel: +(48) 61 864 69 60

Housing:	Dome - Metal
Color:	White
"Index of Protection":	IP67
Operation temp:	-40 °C ... 60 °C
Weight:	0.26 kg
Dimensions:	Ø 91 x 68 mm
Supported languages:	English
Country of origin:	China
Manufacturer / Brand:	Hikvision
SAP Code:	300609496
Guarantee:	3 years

PRESENTATION

Camera is out from clamping ring:



Mounting side view:



Dimensions:

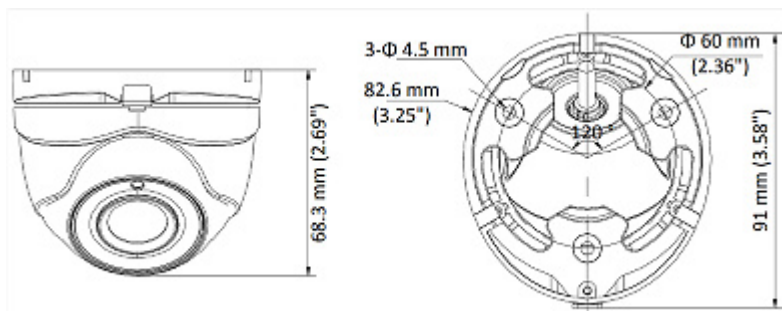

In the kit:



OUR TESTS

Camera image at artificial illumination (about 30Lux):



Camera image at night conditions with internal built-in IR illuminator on:



Camera image at direct strong light opposite to camera:

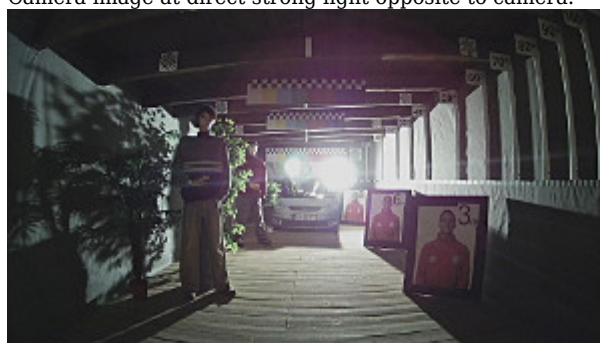



DELTA-OPTI Monika Matysiak; <https://www.delta.poznan.pl>
POL; 60-713 Poznań; Graniczna 10
e-mail: delta-opti@delta.poznan.pl; tel: +(48) 61 864 69 60