

Warning!

Please read the user manual included in this work as it contains important information related with safety of installation and use of the device.

Only persons who read the user manual may use the device.

The user manual must be kept because it may be required in the future. The device is to be used exclusively for purposes specified in this user manual.

The device must be unpacked prior to starting-up. After removing the packaging make sure the device is in working order. If the product has defects, it should not be used until it is repaired.

The product is intended for use at home and commercial use and may not be used for other than intended use.

The manufacturer is not liable for damages resulting from not adhering to the rules contained in the user manual, therefore, we recommend to follow the aforementioned safety rules for operation and maintenance of the device. In this way you will ensure yourself safety and avoid causing damage to the device.

The manufacturer and the supplier are not liable for losses or damages arising out of the product, including financial or intangible losses, loss of profits, income, data, pleasure from use of the product or other products related with it - indirect, incidental or consequential loss or damage. The above provisions apply whether the loss or damage concerns:

1. Deterioration of quality or the lack of operation of the products or products related with it due to damage as well as the lack of access to the product when it is undergoing repair, which results in stoppage the loss of user's time or a break in business activity;
2. Improper results of operation of the product or products related with it;
3. It applies to losses and damages according to any legal category, including negligence and other losses, termination of a contract, expressed or implied guarantee and strict liability (even if the manufacturer or the supplier was notified about the possibility of occurrence of such damages).

Safety measures:

Particular attention at designing was directed to quality standards of the device where ensuring safety of operation is the most important factor.

The device must be secured against contact with caustic, staining and viscous fluids.

The device was designed in such a way that it restarts operation when power supply is restored after a break.

Turn off the device before transporting it.

Prior to connecting the device to a power source check whether the supplied voltage is consistent with rated voltage specified in the user manual.

Attention! We recommend using protections to further protect the device from possible overvoltages in installations. Surge protectors are effective protection against accidental pass to the device voltages higher than the rated. Damages caused by pass the voltages higher than specified in manual, are not under warranty.

Proper product disposal:

A marking of a crossed out waste bin indicates that the product may not be disposed together with other household waste in the entire EU. To avoid possible damage to the natural environment of health due to uncontrolled waste disposal, therefore, it should be handed over for recycling, propagating in this way sustainable use of natural resources.

To return a worn-out product, use a collection and disposal system of this type of equipment or contact a seller from whom it was purchased. He will then be recycled in an environmentally-friendly way.

It is forbidden to use the device in case its power cord or plug is damaged, the device works incorrectly, was damaged or dropped. A damaged power cord or plug must be replaced with new ones by the manufacturer, personnel of service centre or a person with relevant qualifications in order to avoid the risk of electric shock. We do not recommend repairing the device on one's own for safety reasons.

The device is not intended for operation by persons (including children) with limited physical, sensory or mental capabilities as well as persons inexperienced in operation or not competent to operate of such device, unless the operation is supervised by a person responsible for their safety or in line with instructions for use provided by such person.

It is forbidden to touch the plug with wet hands! Pull the plug, never the cable, to pull out the plug from a socket.

The device is to be used exclusively according to its use described in this manual. Use of accessories not recommended by the manufacturer of the device may cause fire, electric shock or injuries.

Marking of a lightning inside a equilateral triangle signifies presence of dangerous voltage, contained under the cover of the device. It may be dangerous for user's life and health.



The HG-140-60W semiconductor heater operates based on a PTC thermistor. Heaters and fan heaters prevent condensation of water vapor and maintain the proper operating temperature of the devices. For optimum circulation of air it is advisable to install the convection heaters in the bottom part of the cabinet in a vertical position.

Attention! The device is designed for use only in closed cabinets. For safety reasons, you should keep a minimum distance of 50mm from the cables and other equipment. The PTC thermistors are not suitable for series connection.

To maintain the constant temperature level in a cabinet, you should connect in series a suitable thermostat to the heater.

Heating element:	PTC thermistor - semiconductor, self regulating
Radiator:	Aluminum - Extruded profiles, Anodized surface
Connectors:	Cable terminals - 3 pcs
Power supply:	110 V ... 265 V AC/DC
Current consumption:	max. 2.5 A - at the time of switching
Power:	60 W
Assembly:	DIN TS-35 rail, vertical
Enabled heater temp:	120 °C ... 140 °C
Operation temp:	-45 °C ... 70 °C
Weight:	0.32 kg
Dimensions:	184 x 70 x 58 mm
Guarantee:	2 years

Front view:



Connectors view:

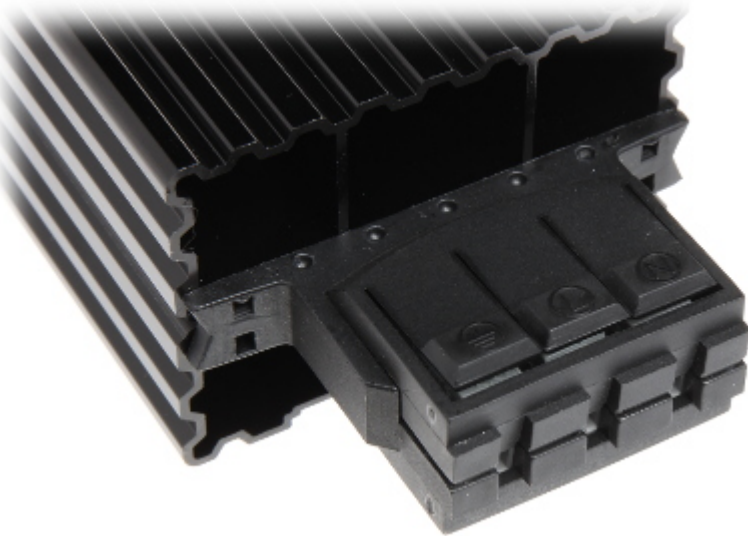

Mounting side view:



Side view:



Top view:

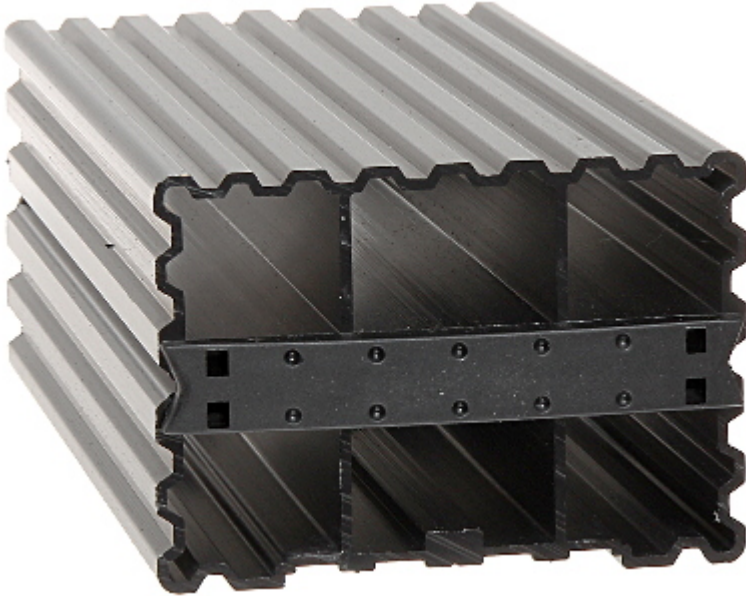

Dimensions:

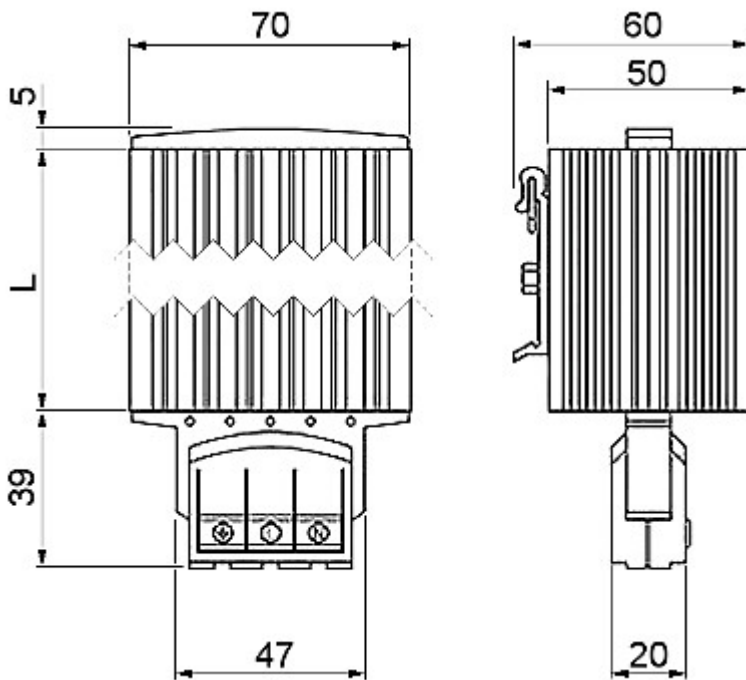

L = 140mm

PACKAGE

Dimensions (L x W x H): 0x0x0 mm	Gross Weight: 0 kg
----------------------------------	--------------------



User Manual

Code: HG-140-60W
SEMICONDUCTOR HEATER **HG-140-60W**
