

Warning!

Please read the user manual included in this work as it contains important information related with safety of installation and use of the device.

Only persons who read the user manual may use the device.

The user manual must be kept because it may be required in the future. The device is to be used exclusively for purposes specified in this user manual.

The device must be unpacked prior to starting-up. After removing the packaging make sure the device is in working order. If the product has defects, it should not be used until it is repaired.

The product is intended for use at home and commercial use and may not be used for other than intended use.

The manufacturer is not liable for damages resulting from not adhering to the rules contained in the user manual, therefore, we recommend to follow the aforementioned safety rules for operation and maintenance of the device. In this way you will ensure yourself safety and avoid causing damage to the device.

The manufacturer and the supplier are not liable for losses or damages arising out of the product, including financial or intangible losses, loss of profits, income, data, pleasure from use of the product or other products related with it - indirect, incidental or consequential loss or damage. The above provisions apply whether the loss or damage concerns:

1. Deterioration of quality or the lack of operation of the products or products related with it due to damage as well as the lack of access to the product when it is undergoing repair, which results in stoppage the loss of user's time or a break in business activity;
2. Improper results of operation of the product or products related with it;
3. It applies to losses and damages according to any legal category, including negligence and other losses, termination of a contract, expressed or implied guarantee and strict liability (even if the manufacturer or the supplier was notified about the possibility of occurrence of such damages).

Safety measures:

Particular attention at designing was directed to quality standards of the device where ensuring safety of operation is the most important factor.

The device must be secured against contact with caustic, staining and viscous fluids.

Expansion plug for solid substrates with hex head screw.

The expansion plug is designed for fixing of light-duty interior finish systems, metal members and lightweight installations or mounting clamps on solid substrates.

Types of substrates for installation: plain concrete of class not lower than C20/25 (PN-EN 206/1:2003), solid clay brick of class not lower than 15 (PN-EN 771-1:2011), aerated concrete of variety 600, class 5 (PN-EN 771-4:2011) and solid sand-lime brick of class 20 (PN-EN 771-2:2011).



Material:	<ul style="list-style-type: none"> • Expansion plug, Polypropylene • Screw, Steel galvanized
Drilling diameter:	12 mm
Expansion plug length:	60 mm
Screw dimensions:	Ø 8 x 60 mm, SW-13

Application:	<ul style="list-style-type: none"> • Concrete • Solid clay brick • Solid sand-lime brick
Manufacturer / Brand:	KLIMAS
Guarantee:	2 years



Method of mounting:

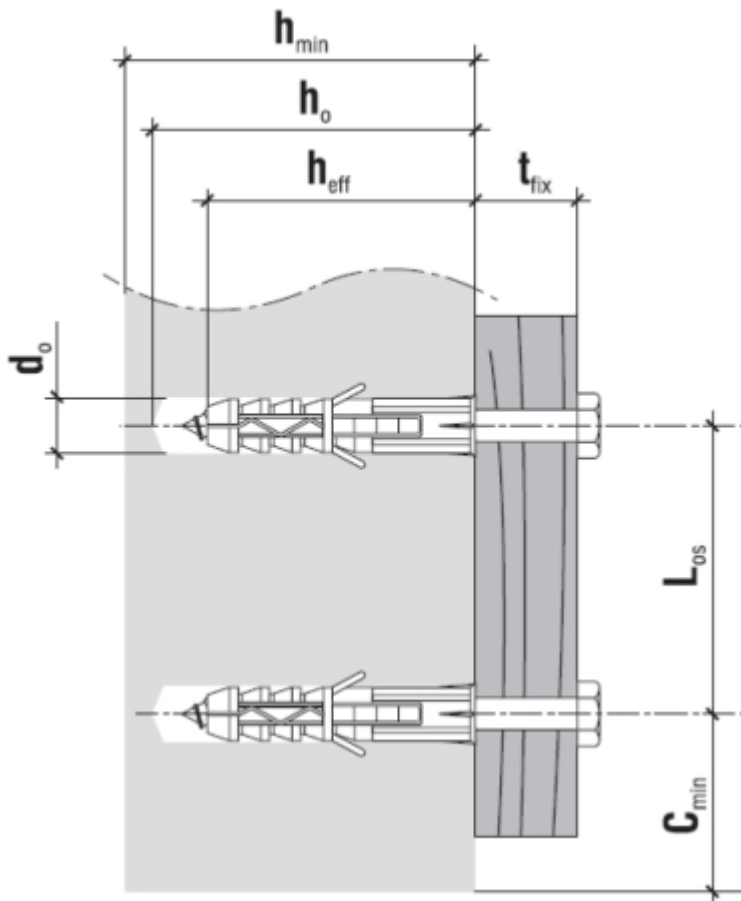

Hole/drill diameter [d_o] - 12 mm

Min. substrate thickness [h_{min}] - 90 mm

Drilled hole depth [h_o] - 70 mm

Anchorage depth [h_{eff}] - 60 mm

Max. usable length [t_{fix}] - 1 mm

Min. axial distance (concrete/other substrate) [L_{os}] - 120/180 mm

Min. distance from edge [c_{min}] - 120 mm



User Manual

Code: KS-12/8X60
EXPANSION PLUG **KS-12/8X60** KLIMAS

PACKAGE

Dimensions (L x W x H): 0x0x0 mm	Gross Weight: 0 kg
----------------------------------	--------------------

